

Handling Precautions

Butterfly valves (common to all models)

For improvement of the product, dimensions or material may be changed without notice.
Please contact us for up-to-date information

Storage conditions

- To protect the seat rings, do not unpack valves until you are ready to install them. If a valve remains unpacked for a long period of time, dust or other particles may enter the valve and cause seat leakage.
- For temporary storage before installing or for long-term storage, keep valves in the vinyl bag in which they came and store them indoors in a cool, well-ventilated location (temperature of -10 to 60°C and humidity of 70% or less). Keep the valve away from dusty locations and take care in protecting the valve and actuator from bearing excessive weights.

Installing valves

- Valves can be installed in any orientation, to allow for the easiest possible operation of the valve. However, be careful of the orientation of the stem when your pipe layout is one of those covered on next page.

Piping instructions

- Verify the materials of the seat ring and disc of the valve before installation.
- When installing a butterfly valve directly to a check valve or pump, install an extension or spacer to prevent the disc of the butterfly valve from contacting the check valve or pump.
- Install the valve only after completing all welding operations around the valve to prevent damage caused by the solder and other welding materials.
- After welding is performed on a flange, wait until it has sufficiently cooled before installing the valve. Never perform welding on a flange with the valve installed.
- In the surrounding piping, make sure that no welding residue, pipe waste, scaling, or dust remain in the pipe. Clean the inside of the pipes if necessary prior to installation.
- Before blowing air to remove any foreign matter in the piping, install an extension tube with face-to-face dimensions equal to that of the valve in place of the valve. Do not blow air with the valve installed in the pipe, for this may damage the seat ring.
- Clean the mating surface of the flange with compressed air before installation. Remove rust or foreign particles with cleaning alcohol or a neutral detergent.
- With a zinc plated flange, attention must be paid to avoid flange leakage due to an uneven surface of the flange.
- Make sure that there is no warpage in the flange, misalignment, or damage to the mating surface of the flange.
- Be sure to properly align the valve and mounting flanges.
- Install the jack bolts taking care not to damage the seat ring of the valve and adjust the face-to-face dimensions. The face-to-face dimensions should be such that the piping is spread open 3 to 5mm to allow the valve to be inserted. (A jack bolt is available on request.)
- If possible, avoid mounting the actuator with it facing downward. Especially for valve sizes of 350mm or larger, where the lower portion of the valve stem bears thrust loads, never install the actuator facing downward.
- After centering the pipes, insert bolts at the proper locations so that the bottom of the valve can rest upon them to prevent the valve from falling through.
- Before tightening the installation bolts, make sure that the disc of the valve does not contact any portion of the flange when it

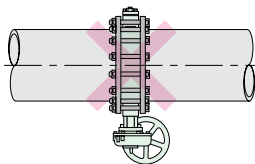

is fully opened.

- Tighten the installation bolts to a torque of no more than 60Nm (6kgfm).
- The installation bolts should be tightened evenly and in the proper sequence. Tighten one bolt a small amount, and then proceed to another bolt that is located on the other side. Proceed tightening each bolt a little at a time by crisscrossing across the flange to insure well-balanced tightening.
- Upon completion of installation, fully open and close the valve once again to make sure that the disc does not touch the piping or gasket.

Operational instructions

- Prior to operation, clean the outside of the piping with compressed air, and the inside of the piping with running water.
- If the valve is to be used at an opening angle of 30° or under for flow constriction, consult us before hand.

Also...

- After installation, open and close the valve once every two weeks if the valve is not used for a long period of time, and open and close the valve a few times before starting actual operation.
- For pressure tests of the piping (where pressures exceed the rated pressure), always keep the valve fully open. Never fully close the valve or use it as a blind flange.
- If the actuator is a manual gear, pneumatic cylinder, electric motor, diaphragm or other similar type, and the ambient temperature is extremely high, it may be necessary to change the O-rings and other rubber components using special materials, or change the motor or solenoids to those with higher insulation levels, so be sure to consult us before hand.
- Always operate lock lever, worm gear, or center handle type actuators by hand. Never use an extension bar on the lever or a wheel key on the gear handle, for they might damage the handle or lever. Unlike gate valves or globe valves, tightening with a high torque is unnecessary.
- Do not loosen the installation bolts or other bolted components before relieving the system pressure.
- To avoid any damage, which may be caused by vibration of piping to a valve, provide a 3D to 5D straight distance from any nozzle orifice or control valve which may be installed at the upper stream of the piping line. (See correct example of a combination of control valve and stop valve on the right.)
- A valve 350mm or over may have a nut and bolt on the center of the bottom cover to support the weight of disc. Please do not touch it.
- Do not touch any open/close adjusting bolts and screws on any actuators (gear/pneumatic cylinder/electric motor) as these were pre-adjusted.

We will indicate level of danger caused by neglecting these cautions as the following:



CAUTION

this mark indicates " possibility of serious injury to personnels or damage to components "

We will indicate following marks for your attention.



this mark indicates that " you must not "

! CAUTION



Forcing the valve between the pipe flanges may cause the seat ring to peel off and cause a leak.

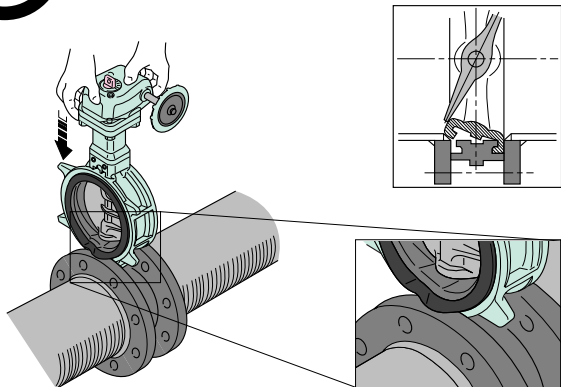

Below are causes of damage to the valve seat or leakage from the flanges.

- **Excessive weld**
The resulting oversized inner pipe diameter may cause a flange leak.

- **Sharp edges**
May cause damage to the seat ring.

- **Rough surface from grinding**
May cause a flange leak.

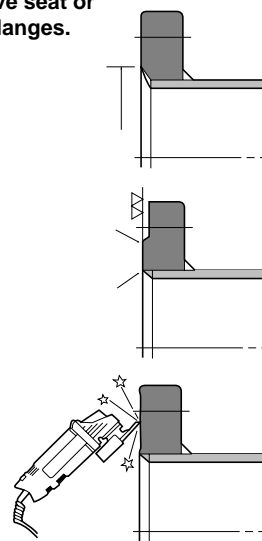

Do not touch the stopper bolts of the gear box.

The closed position for the valve will change and result in leaking.

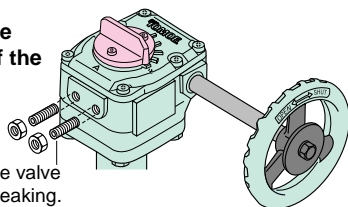

Do not install a valve to a flange that has just been welded.



Wait until it has sufficiently cooled before installing the valve. Never perform welding on a flange with the valve installed.

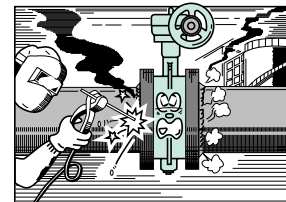

Do not throw or mishandle the valve. Do not stand on or put objects on the actuator.

Installing a valve at a pump outlet

Incorrect installation orientation

Correct installation orientation

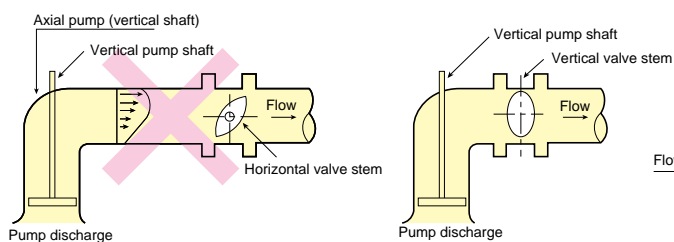
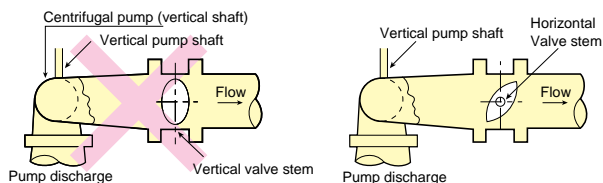
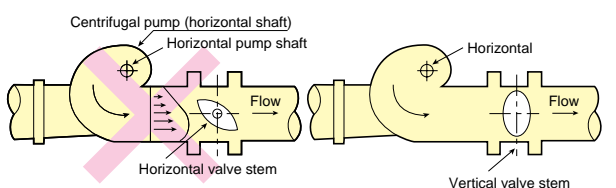

Installing at an elbow or a reducer

Incorrect installation orientation

Correct installation orientation

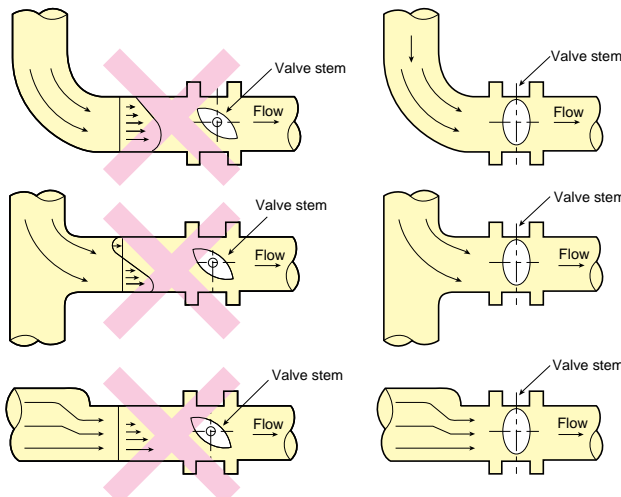

Combination of a control valve and stop valve

Incorrect installation orientation

Correct installation orientation

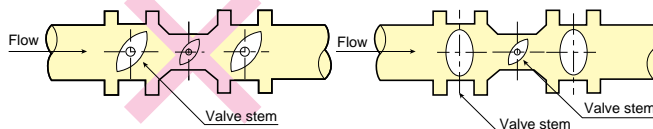

All the valve stems have the same orientation.

The orientation of the valve stems is alternating.

Handling Precautions

High performance butterfly valves

TT2

334A

Tom Disco® 302A /304A

Tom Disco® 302Y/304Y

304M(HLV)

Storage conditions

- Since the Teflon used in the seat rings is easily damaged, do not remove the protective covers on both sides of the valves until you are ready to install the valve (dust or other foreign particles may enter the valve and cause leakage).

Precautions regarding piping

- If valve models 337Y/336Y are used in temperatures exceeding 300°C, use the specified spiral-wound gaskets.
- The gaskets must be properly aligned with the pipe flanges and the valve.
- Do not use Teflon-covered gaskets or soft gaskets such as rubber gaskets.
- If the actuator is installed so that its weight falls on the piping (e.g. when horizontally installed), install supports for the actuator and bonnet (especially in the case of extension bonnet and fin bonnet types).
- When fluids over 100°C are being used, install insulating materials to the valve body where possible.

Installation instructions

- Check the direction of flow prior to installation.
- Do not apply pressure to or lean on the lever or gear handle during installation.
- Do not use plastic flanges.
- When installing or removing the valve, keep the disc fully closed.

- Before installation, clean the inside of the pipe and flange surface. Make sure that no welding residue, rust, scaling, or dust remain in the pipe. If possible, install an extension tube with face-to-face dimensions equal to that of the valve in place of the valve and blow the inside of the piping clean with compressed air. Then clean the flanges and re-install the valve.
- Never weld on the up-or down-stream pipes while the valve is installed.
- To prevent stresses from accumulating during the installation process, fix the up-and down-stream flanges after installing the flange.

Operation instructions

- If leakage from the gland occurs during operation, immediately retighten the gland nuts. The nuts should be tightened alternately and evenly in a diagonal pattern, to avoid imbalance.
- For room temperature or cold to hot heat cycles, or batch flow such as form the base valve of a steam header, be sure to insulate the valve body. Also, warm up the disc before starting operation.

Rearrangement of actuator

- When removing and remounting the actuator to change its orientation at the job site, align the marks (punch marking) on the top of the valve and the top of the valve stem to ensure proper positioning for the fully-closed position.

Replacement of packing

- When replacing gland packing or seat ring, close the base valve and remove the valve from the piping.

Also...

- Before using a valve after it has not been used for a long period of time, open and close the handle once or twice.

Rotary control valves

Installation instructions

- For rotary control valves (including butterfly valves), basically the rotation of the disc alters the area of the flow path and thereby controls the flow. Therefore, unlike globe valves, if an elbow or tee is placed upstream from the valve, the valve is directly affected by the disturbed flow and cavitation, noise, vibration, or other problems result. In the worst case, this may cause an imbalance of torque on the valve and result in rendering the actuator ineffective. To avoid these problems, install a straight pipe of a sufficient length (at least 6 to 8D) in the valve up-and down-stream side, and carefully consider the orientation of the valve to minimize the affect of drift. In addition, when installing stop valves in front of and behind the valve, leave a space of at least 6D in between.
- The concave side of the disc (the side with the stem exposed) must face upstream.
- Do not use plastic pipes and loose flanges.
- When installing or removing the valve, keep the disc fully closed.

507V

Installation instructions

- Use a gasket when installing the valve.
- If using a diaphragm actuator, the actuator must be installed vertically.

Operation instructions

- If leakage from the gland occurs during operation, immediately retighten the gland nuts. The nuts should be tightened alternately and evenly in a diagonal pattern, to avoid imbalance.

508V

Installation instructions

- Since no gasket is required, do not install one.
- Valves can be installed in any orientation, to allow for the easiest possible operation of the valve. However, be careful of the orientation of the stem. Also, for valve sizes of 350mm or larger, never install the actuator facing downward. (Refer to "a Handling Precautions".

Operation instructions

- The pressure rating of the valve body is ANSI Class 300 (50 to 200mm) and ANSI Class 150 (250 to 400mm). However, since the pressure rating for the valve disc and stem is lower, be sure to have the valve in the open position when performing hydraulic pressure testing of the piping.

Chemically resistant butterfly valves

Installation instructions

- Except for Models 846T and 847T, a butterfly valve should be installed on a pipeline with gaskets in between piping flanges. For the gasket sizes, adhere to the recommended gasket sizes listed in this catalog and always use a gasket sealer to assure reliable sealing.
- Never use a soft gasket such as rubber gaskets. Doing so may cause malfunctions.
- When installing or removing the valve, keep the valve disc opened to an approximate 10° angle.

841T/842T

Storage conditions

- Since Teflon is easily damaged, do not unpack the valve until you are ready to install it in the piping.

Installation instructions

- Insert a gasket between the valve and flange. For the gasket size, adhere to the recommended gasket sizes listed in this catalog.
- Do not use rubber or other soft gaskets. Doing so may cause malfunctions.
- After centering the pipes, insert bolts at the proper locations so that the bottom of the valve can rest upon them to prevent the valve from falling through.

846T/847T

Storage conditions

- Since Teflon is easily damaged, do not unpack the valve until you are ready to install it in the piping.

Installation instructions

- As a rule, these valves do not require a gasket for the pipe flanges. However, if a flange surface is not flat due to scratches, dents, or other such reasons, install a commercially-available gasket. However, do not use rubber or other soft gaskets. Doing so may cause malfunctions.

Handling Precautions

Rubber seated valves

Installation instructions

- Align the pipes and insert the valve between them.
- Since no gasket is required, do not install one. Installing one may cause malfunctions.
- When installing or removing the valve, keep the valve disc opened to an approximate 10° angle.
- Do not install a butterfly valve with a rubber seat directly to a rubber flexible joint. The direct connection will result in the improper functioning of the valve. In this case, place a spacer or a mating flange on both sides of the valve between the valve and the rubber flexible joints.

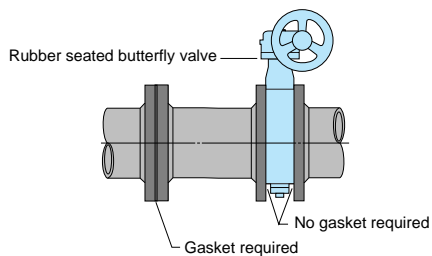
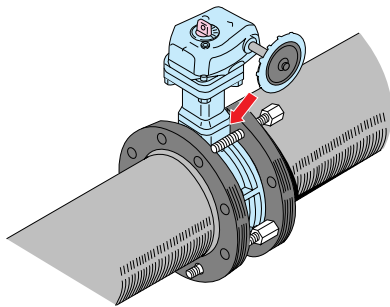

773Z/778Z

Installation instructions

- Insert bolts to support the upper rib of the valve when 3/4 of the valve is inserted between the flanges.

700G/704G/705G

Installation instructions

- Insert bolts to support the upper rib of the valve when 3/4 of the valve is inserted between the flanges.
- To center the piping for JIS 10K flanges, insert centering sleeves on the bolts and install the bolts to support the valve at the bottom and prevent it from falling through (only for 100, 125, and 150mm sizes).

*Use the provided centering sleeves to facilitate the operation.

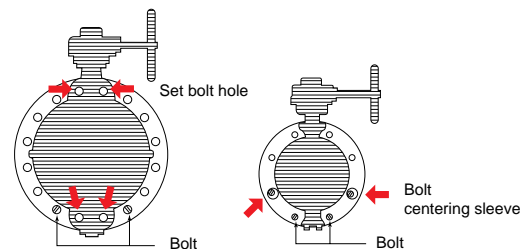

731P/732P 732X/731X

700E/700K

704G/722F/720F

LRV

227P

Storage conditions

- When stored for a long period of time, the FCD disc (ductile cast iron) and other plated parts (opening/closing board, bolts, nuts, worm shaft, etc.) should be coated with the specified "Ferro Guard" rust preventative once a year.

Installation instructions

- Avoid solvents from touching the seat ring. Attention must be paid to prevent all materials other than NBR and Viton from being exposed to machine oil.

Anti-Vibration check valve

MKT

Installation instructions

- Installation of the MKT immediately after welding the pipe flange will lead to adverse consequences, such as damage to the seat. Make sure that the temperature has cooled sufficiently and that you have removed weld spatter before installing the MKT. Never weld when the MKT is in the piping. (Fig. A)

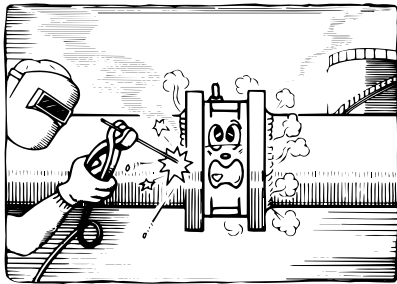

Fig.A

- The flange may leak if the flange face that contacts the MKT is as shown in Fig. B. Also, please confirm that there is no distortion to the flange or that there is no damage, such as scratches, to the flange face.

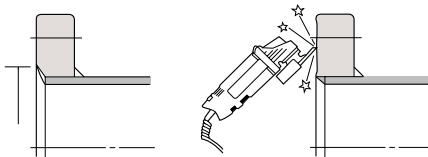

Fig.B

- Excessive weld**
The resulting oversized inner pipe diameter may cause a flange leak.
- Rough surface from grinding**
May cause a flange leak.
- Always be sure to use a piping gasket. The piping gasket will enter the piping inside and cause malfunction if a rubber or similar soft gasket is used. Therefore, make sure that the piping gasket does not enter the radius of MKT plate operation. (Fig. C)

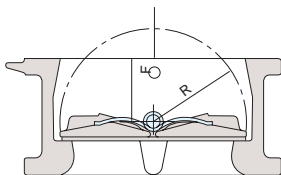

Fig.C

- Align the MKT to the flanges accurately. Malfunction can occur if the pipe edge or piping gasket enters the radius of MKT plate operation.
- Do not apply strong shock such as by throwing the MKT.
- When installing butterfly valve and MKT, always insert a short pipe in between. Not doing so will cause the disc to hit during operation and lead to faulty operation. (Fig. D)

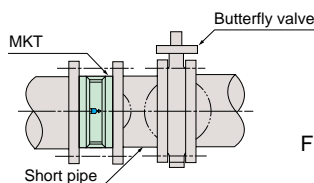

Fig.D

- Direct installation on the pump is possible, but please be sure to follow the cautions below.
 - If the flow rate distribution is uneven immediately after the spiral pump, etc., make the flow rate distribution that is received by both plates of the check valve equal by installing so that the direction of change in the flow rate distribution crosses at a right angle the hinge pin direction, as shown in (Fig. E)
 - Use with an average pump exit flow rate of no more than 10 m/s (fresh water).
 - If fluids exceed a flow rate of 5 m/s, cavitation may occur from the check valve. Therefore, separate the valve or other device on the secondary side by at least 2D when installing.
 - Be careful of pressure loss in the check valve. (Refer to the pressure loss table.)

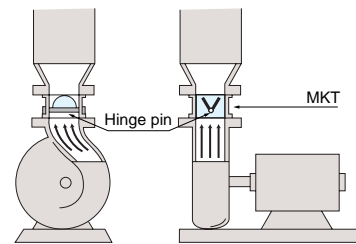

Fig.E

- Please consult us when the liquid velocity flow exceeds 10 m/sec.
- Seat leakage may occur if the pressure difference is less than 0.04 MPa.
- Make sure no solvent gets onto the seat ring. If EPDM rubber is used, always keep the seat ring away from any machine oil.
- When installing the check valve, the installation direction should be in accordance with the following.
 - For a horizontal installation make sure the check valve hinge pin is vertical. (Fig. F)

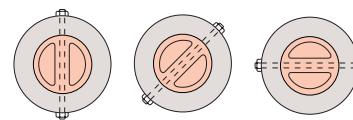

Fig.F

- For elbow or pump exit installations, make sure the influence of the flow rate on the plate is well balanced. (Fig. G)
- For installations on the secondary side of butterfly valves, make sure the valve shaft of the butterfly valve and the hinge pin of the check valve crosses alternately.

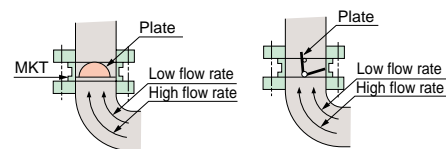

Fig.G

Although vibration caused by the pump and fluid will not affect MKT series valves, please install flexible piping or similar in order prevent vibration from affecting any secondary piping and devices.

Handling Precautions

Wafer check valves

903C/904C

Installation instructions

- Install the valve so that the cast marking on the body of the Bata-Check corresponds with the flow direction. (Fig. 1)
- Vertical installation is also possible.

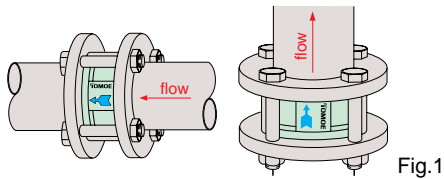

Fig.1

- For horizontal installation, have the rib of the Bata-Check aligned vertically. (Fig. 2)

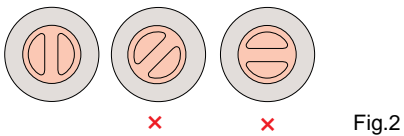

Fig.2

- Always place an extension pipe between a Bata-Check valve and butterfly valve. Never connect the two valves directly together. (Fig. 3)

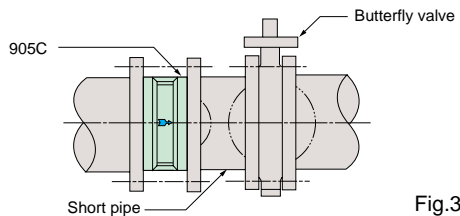

Fig.3

- Make sure that the end of a pipe or gasket does not come within the operating radius of the plate of the Bata-Check valve. (Fig. 4)

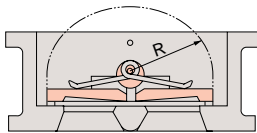

Fig.4

- When mounting a reducer in front of a Bata-Check valve, have a space of 5 times the valve diameter (5D) or more, or at least 2 to 3D between the valve and reducer. (Fig. 5)

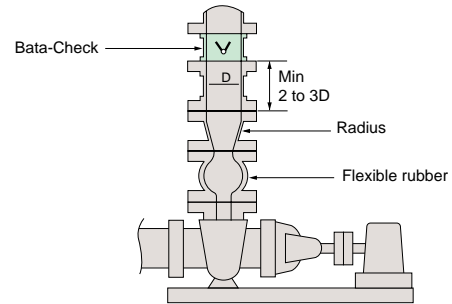

Fig.5

- When installing a Bata-Check valve near an elbow, have as large a space as possible between the elbow and the Bata-Check valve. Also, make sure that both plates are stressed evenly by the flow. (Fig. 6)

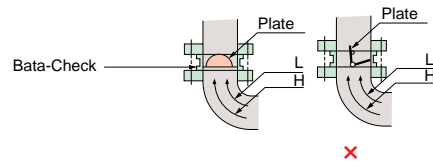

Fig.6

- When installing a Bata-Check valve at the outlet from a pump, leave a space of at least 6 times the valve diameter (6D) between the valve and pump. Also, make sure that both plates are stressed evenly by the flow. (Fig. 7)

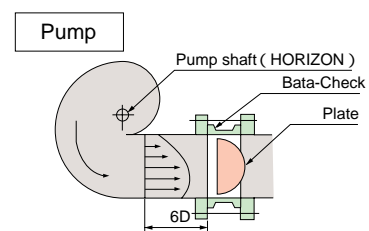

Fig.7

- Consult us when the liquid velocity flow exceeds 3m/sec.
- Seat leakage may occur if the pressure difference is less than 0.02Mpa.

Actuators

Motorized Actuators

Handling precautions

- The built-in spare limit switch for the fully opened and closed positions of the motorized actuator (non-voltage output switches for the fully opened and closed positions) is adjusted at the factory to output approximately 2% ahead of the position for actual sealing at the rated pressure. This is done to activate the limit switches with different cams. Since the positioning switch and opening angle detection switch must not activate simultaneously, the spare limit switch is set to always activate first. Therefore, if this output is used to stop the motor or signals, the valve will stop at that position and the sealing ability will be compromised. If your control requirements or other factors require that valve positioning be determined by the spare limit switches, be sure to inform us at the time of ordering. We will then adjust the output position for the spare limit switch to correspond to the fully closed position.
- Each electric motor actuator should be operated by an independent circuit breaker or relay. If more than two electric motor actuators are operated by one circuit, erroneous operation may result due to a loop circuit.

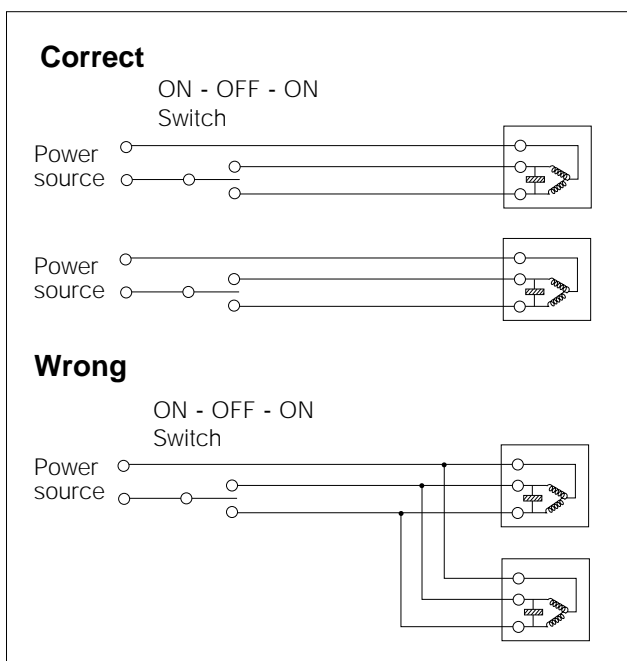

- Prepare a protection cover for the electric motor actuator to protect it from any corrosive fluid, such as cooling water with hypochlorous acid that spreads out from a cooling tower directly. If no protection is provided, the sealing parts and actuator housing may become damaged.
- Prevent hunting of electric motor actuator with proper PID adjustment when employing it for proportional control purposes. Otherwise, the life of the valve and actuator will shorten due to wearing of the friction and connection parts.

New ELMY®

Handling precautions

- Perform the wiring in accordance with the diagram on the inside of the casing cover. After completing the wiring, verify the wiring connections carefully to make sure there are no mistakes.
- To prevent rainwater and the like from entering the unit at the two wiring outlets (G1/2), take the appropriate measures to assure a watertight seal.
- Every cover of the actuator is sealed with an O-ring sealing gasket. Take care not to damage the gaskets during disassembly or assembly of the actuator.
- Except for the top cover, all the screws for the covers have a sealing agent applied to them to prevent the screws from working loose. When removing a screw, take care not to strip the head of the screw with the screwdriver. Also, when installing a screw, apply a sealing agent to the screw and then install it.
- When adjusting the open/close limit switch, be sure to release the lock nut on the stopper bolt and then loosen the stopper bolt by 4 to 5 turns.
- Make a 0.5 second interval when reversing the electric motor actuator from intermediate position utilizing a potentiometer. Surge current generated from a motor may create some damage to the switching relay when reversing it. Modifications to the reduction gear or upgrading of the actuator may be required. Consult us.
- Each electric motor actuator should be operated by an independent circuit breaker or relay. Erroneous operation may be caused by a loop circuit if more than two motor actuators are operated by one circuit breaker or relay.
- Manual operation unit should be used after the power supply is cut. It may suddenly turn if the power is supplied.

Handling Precautions

Actuators

New MICOM ELMY II



The **WARNING** mark indicates the possibility of death or serious injury.

- Before wiring the actuator, make sure that the power supply matches that listed on the specifications plate on the actuator. If the wrong voltage is supplied, it may cause the actuator to burn out.
- Be sure to connect the earth terminal to avoid electrical shocks.
- To prevent rainwater and the like from entering the unit at the two wiring outlets (G1/2), take the appropriate measures to assure a watertight seal. If moisture enters the unit, it may damage the actuator or cause it to burn out.
- If you need to touch a dip switch or reset a switch for adjustment or inspection, do not touch any other components or terminals on the circuit board. Careless touching of components or terminals may cause electrical shocks.



The **CAUTION** mark indicates the possibility of serious injury or damage to equipment.

- All necessary settings are completed prior to shipment from our factory. If any modifications or adjustments are required, follow the directions given in the instruction manual. Incorrect procedures may cause improper operation or damage to the components.
- When wiring the actuator, be sure to follow the circuit diagram. Be sure to then verify that there are no mistakes before supplying power to the actuator.
- The input and output signal wires in the unit built into the actuator are not insulated. If insulation is required, install a converter on the outside of the unit. Not doing so may cause improper operation.
- When setting the dip switches, do not apply excessive force as this could damage the switches.
- The input signal has preference over the contact input of a 4 to 20mA signal. If the 4 to 20mA signal is used for control, then be sure to eliminate the contact signal. Failure to do so may cause improper operation.
- When two actuators are controlled by one input signal, make sure that the signal is within the allowable load resistance of the output side. Failure to do so may cause improper operation.
- Do not apply loads over the capacity of output contacts for the opening angle, alarms, or stop signals.
- There are times when the surface of the actuator becomes hot during operation. This is caused by the heat from the internal motor and not due to a malfunction. However, if valve operation is more frequent than the allowable amount, the temperature alarm may sound and cause a compulsory stop.
- Every cover of the actuator is sealed with an O-ring sealing gasket. Take care not to damage the gaskets during wiring or inspecting of the actuator. The sealing properties will decrease, which may lead to malfunction.
- Except for the top cover, all the screws for the covers have a sealing agent applied to them to prevent the screws from working loose. When removing a screw, take care not to strip the head of the screw with the screwdriver.

Pneumatic Actuators



The **WARNING** mark indicates the possibility of death or serious injury.

This unit should be handled by well-versed and experienced technicians only.

- Compressed air is hazardous if wrongly handled. A machine or a unit utilizing compressed air should be handled by a well-trained professional technicians only.

Handling or dismantling of the unit should not be carried out before confirming the safety precautions.

- Inspection and maintenance should commence only after acknowledgment of safety precautions such as preventions against falling of parts or material or other accidental happenings.
- The unit should only be dismantled after confirmation of the above safety precautions and after removal of the air supply and power sources.
- Before restarting of the unit, ensure that the action of the movements are in a safe and normal position.

Handling precautions

- During installation, make sure that no dust or any foreign matter enters through the air port.
- When attaching joints to taper screws on the air port, make sure that you screw them in properly and straightly. Do not overtighten as you may damage the threads. Also, be careful during the initial threading to ensure the proper catching of the threads.
- Use a speed controller to control rotating speed. Use a pressure reducing valve for speed adjustment.
- In the airline, install an air filter to remove any moisture or dust from the air. Moisture or dust will deteriorate the valve and shorten its operating life.
- Avoid use in ambient temperatures over 80°C. Use in such high temperatures may cause malfunctions.
- Do not subject the cylinder or peripheral components to excessive forces such shocks or impacts with other objects.
- This cylinder is a non-lubricated type, however, you may provide lubrication for the protection of peripheral equipment. (Use JISK-2213 turbine additive oil No.1, No.2, or similar oil. Never use spindle oil or machine oil, as they deteriorate the O-rings and other rubber components.)
- Periodically check and retighten the bolts.
- Check and clean the actuator once a year even if it is not or has not been in use.
- If an external or internal air leak occurs during operation, inspect the actuator and check the condition of the O-rings and look for abrasion of the moving parts. If any component is damaged, replace it with a new one right away.

I-DYNAMO

Handling precautions

- The hexagonal bolts that retain the cover must not be slackened.
- On single acting types, removal of the cover will cause the spring to eject out, due to its tensile strength impact and may cause injury or damage. In case of abnormal operation of the unit, customers are requested to contact our sales department.
- In the case of single acting actuators being installed outdoors, a rain-prevention precaution is required: the elbows on the air inlet/outlet ports should be oriented downwards, for example.